

Pressure Transmitter
With Current Output (2-wire)
PT2000PSIG-2021-I2-H1143/X

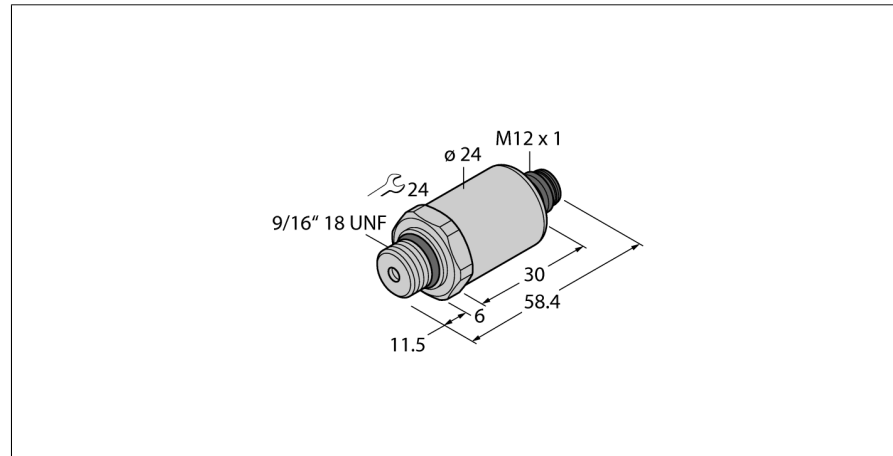

- Fully welded metal measuring cell
- Pressure range 0...2000 psi rel.
- Pressure tip orifice
- 7...33 VDC
- Analog output 4...20 mA
- Process connection 9/16"-18 UNF (SAE) male thread
- Plug-in device, M12 × 1

Wiring Diagram

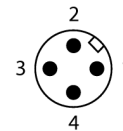
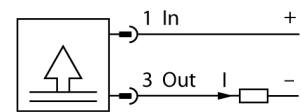

Functional principle

The pressure sensors of the PT...-2000 series operate with a fully welded metal measuring cell. Depending on the sensor variant, the processed signal is available as an analog output signal of either (4...20 mA (2-wire) or 0...10 V, 0...5 V, 1...6 V (3-wire)).

Type designation	PT2000PSIG-2021-I2-H1143/X
Ident-No.	100001199
Pressure range	
Relative pressure	0...137.9 bar rel. 0...2000 psi 0...13.79 MPa
Admissible overpressure	≤ 206.84 bar
Burst pressure	≥ 827.37 bar
Response time	< 2 ms, typ. 1 ms
Long-term stability	0.25% FS, according to IEC EN 60770-1
Power supply	
Operating voltage	7...33 VDC
Current consumption	≤ 23 mA
Short-circuit/reverse polarity protection	yes / yes
Protection type and class	IP67 / III
Insulation voltage	750 VDC
Outputs	
Output 1	Analog output
Analog output	
Current output	4...20 mA
Operating range	4...20 mA (2-wire)
Load	≤ (Supply voltage - 7)/20 kΩ
Accuracy LHR analog output	± 0.3 % FS BSL
Temperature behaviour	
Medium temperature	-40...+135 °C
Temperature coefficient	± 0.2 % of full scale/10 K
Ambient conditions	
Ambient temperature	-30...+85 °C
Storage temperature	-50...+100 °C
Vibration resistance	20 g, 15...2000 Hz, 15...25 Hz with amplitude +/-15 mm acc. to IEC 68-2-6
Shock resistance	100 g, 11 ms, half sinusoidal curve, all 6 directions, free fall from 1 m onto concrete (6x) , acc. to IEC 68-2-27
Housing	
Housing material	Stainless-steel/Plastic, 1.4404 (316L)/ Polyarylamide 50 % GF UL 94 V-0
Pressure connection material	Stainless steel 1.4404 (AISI 316L)
Pressure transducer material	Stainless steel 1.4435/AISI 316L
Process connection	9/16"-18 UNF male thread
Wrench size pressure connection / coupling nut	24
Electrical connection	Connector, M12 × 1
Max. tightening torque housing nut	20 Nm

Pressure Transmitter
With Current Output (2-wire)
PT2000PSIG-2021-I2-H1143/X

Reference conditions acc. to IEC 61298-1

Temperature	15...+25 °C
Atmospheric pressure	860...1060 hPa abs.
Humidity	45...75 % rel.
Auxiliary power	24 VDC

MTTF	1189 years acc. to SN 29500 (Ed. 99) 40 °C
-------------	--